

1. GRAPHIC ATTACHMENT

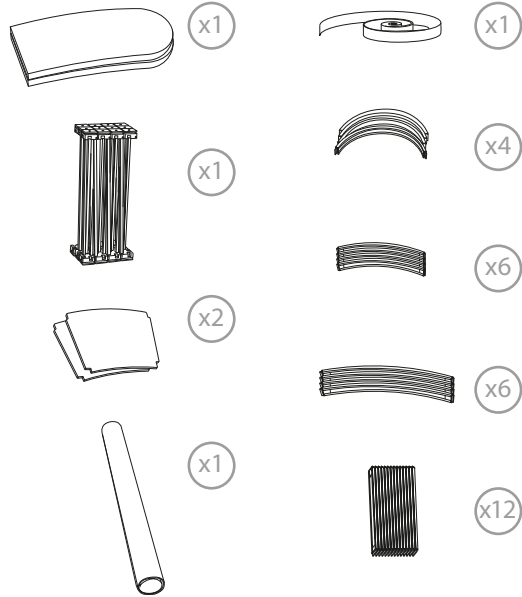

CONTENT



Open the bag, check the content of the bag and take out all the pieces carefully.

To assemble the promotional counter, first unfold the structure and secure it with the connecting sections. Then, set-up the inner shelf that consists of 2 sections, and finally, unfold the top shelf and place it on the top of the promotional counter.

GRAPHIC ATTACHMENT BY SHELF ADHESIVE STRIP

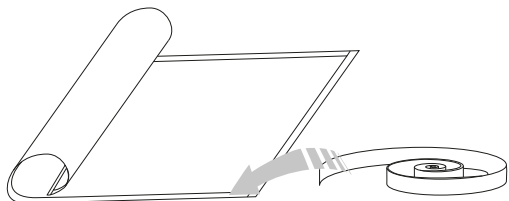

To set-up the graphic support, attach the adhesive and magnetic strip (included) along the perimeter of the graphic support. Then wrap the counter magnetically with it.

For those cases in which the graphic is **supplied by the client**, we recommend making use of the materials listed in the following **QR code** (scan for downloading Excel file). Please contact us or visit www.cashdisplay.com for more information.



2. SET UP THE STRUCTURE

