

1. SET UP THE POP UP STRUCTURE

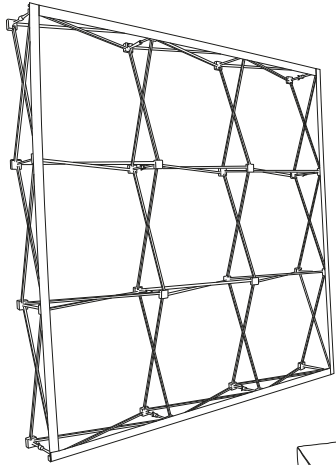

 CONTENT



x1

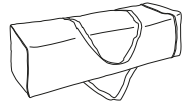

x1

Open the bag, check the content of the bag and take out all the pieces carefully.

To set-up the Pop Up, first it is recommended to unfold its structure on the ground and not standing up until having attach the graphic, as shown in the next 2 steps below.

1

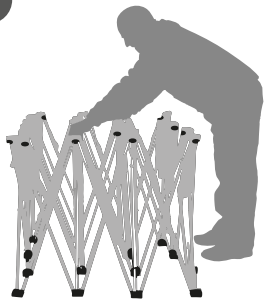

2

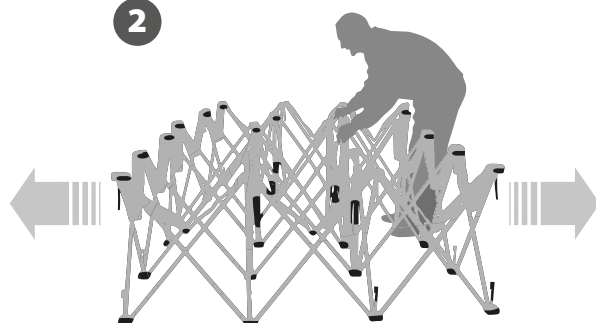

For those cases in which the graphic is **supplied by the client**, we recommend making use of the materials listed in the following **QR code** (scan for downloading Excel file). Please contact us or visit www.cashdisplay.com for more information.



2. SET UP THE POP UP STRUCTURE

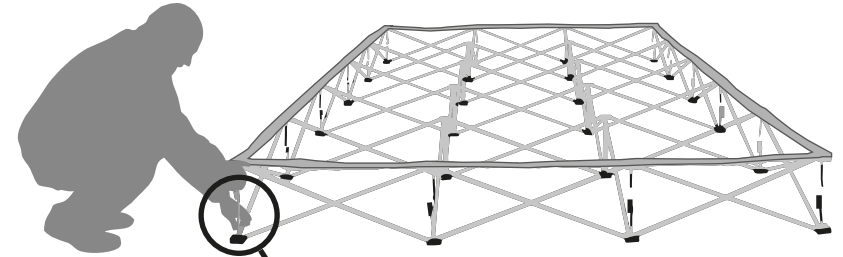

3

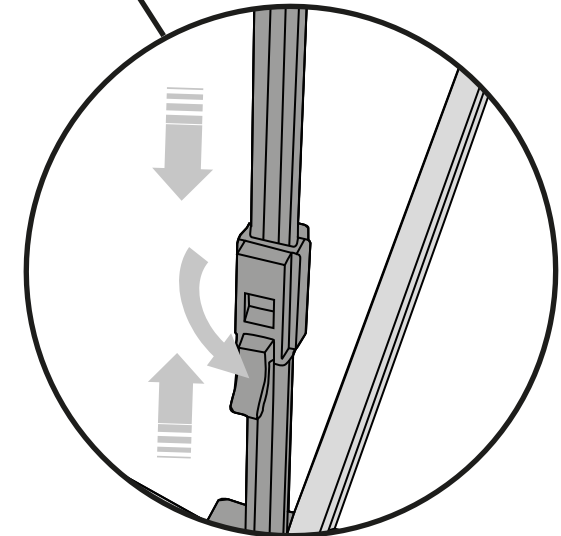

3. GRAPHIC ATTACHMENT

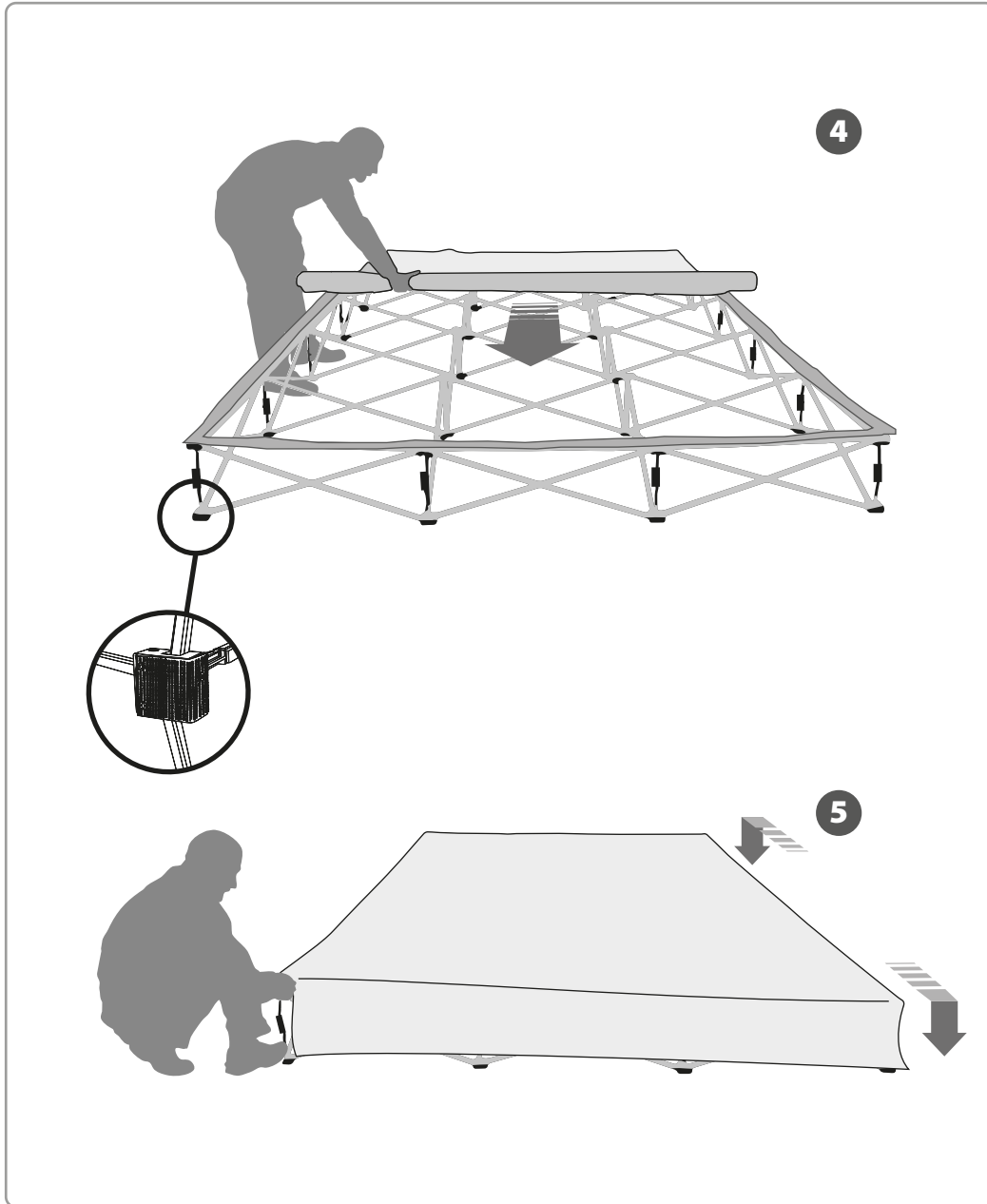

4. STANDING UP THE POP UP

